

TREE GUARD

M-5

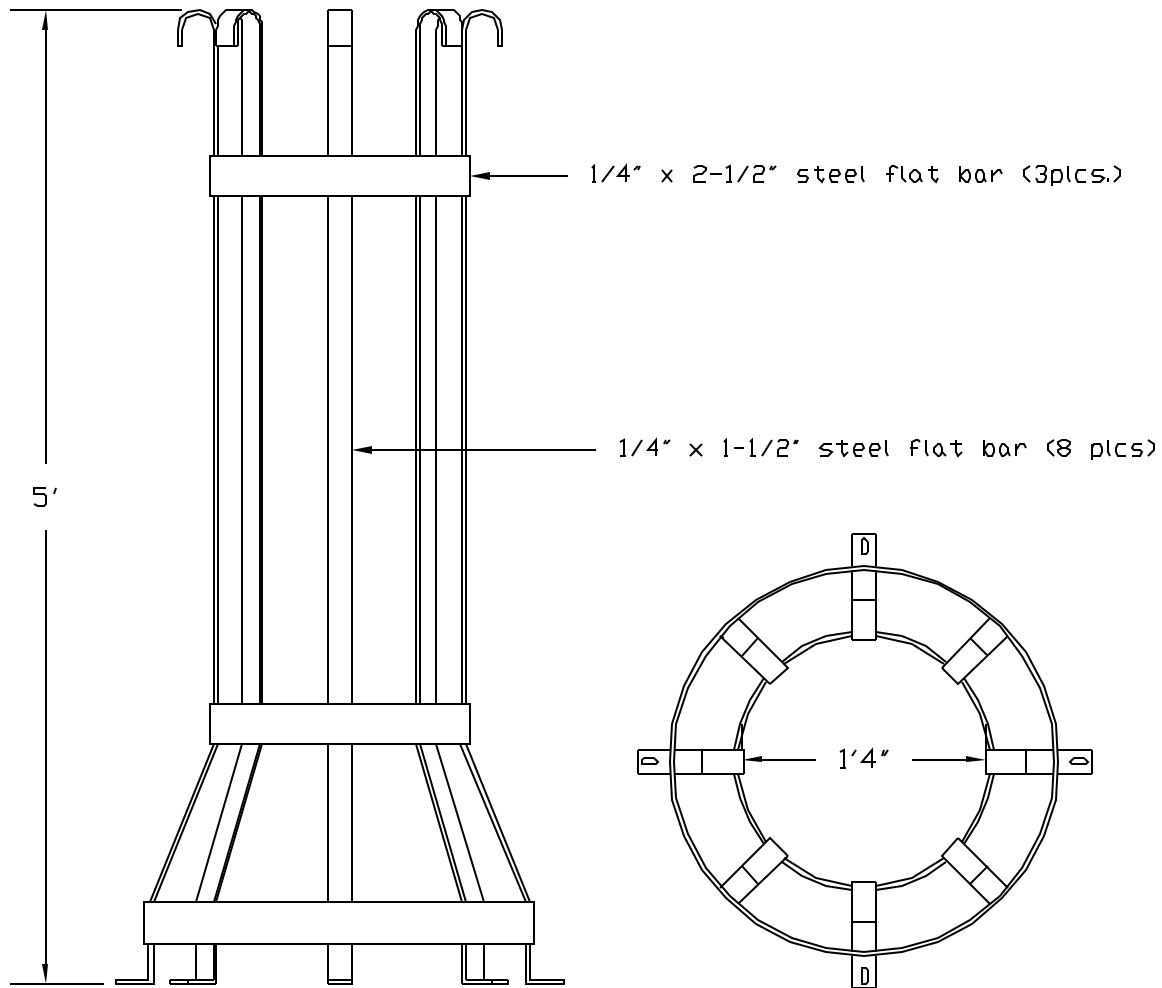

- Jig welded from hot rolled steel.
- Guards are constructed in halves and bolt together
- 60" height and 16" tree opening standard
other dimensions available for additional cost
- Alternate attachment methods available
- All hardware provided by IRONSMITH
- Black powder coat standard finish
other finish options available